

Power Fan Heater WDH-IFH20 (20 kW)

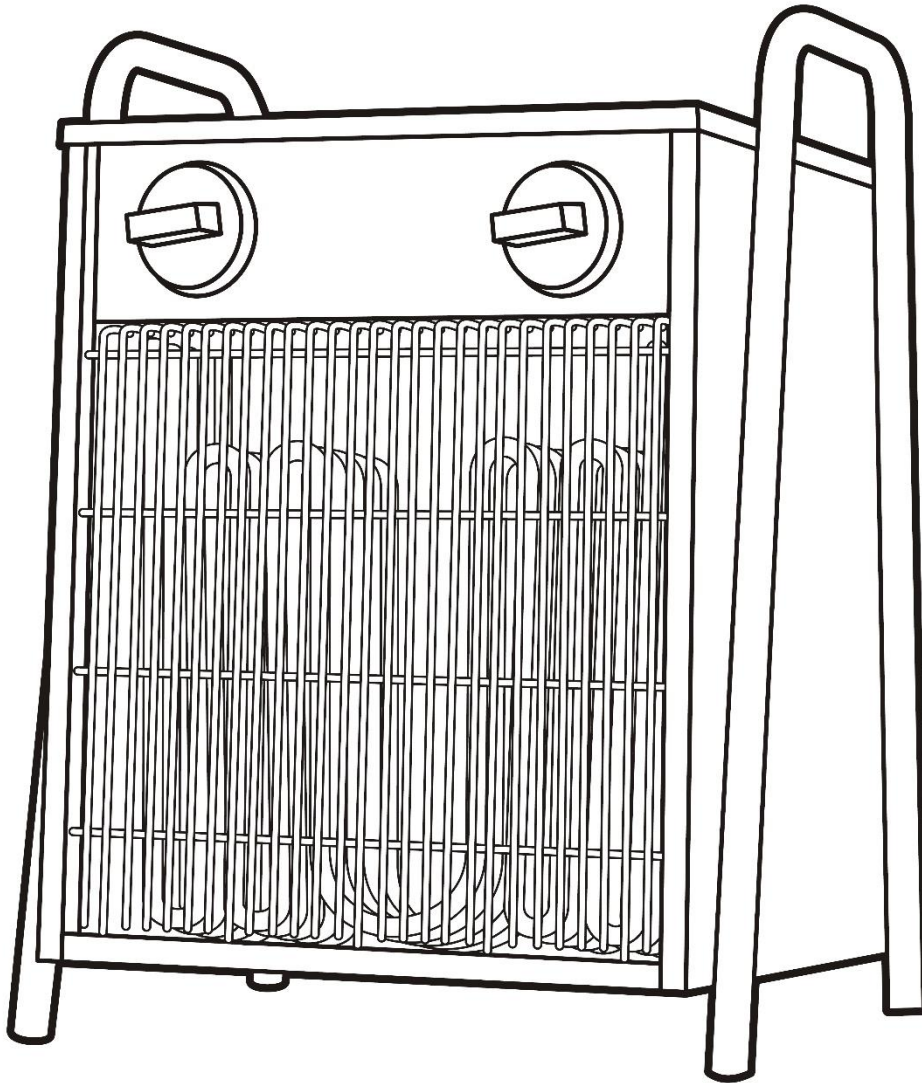

Dear Customer,

You have chosen a high-quality product. To ensure that you get a lot of enjoyment from this product, here are a few more tips:

Information relevant to energy consumption:

This product is only suitable for well-insulated rooms or for occasional use.

In case of any problems:

We hope that the unit meets your expectations! If, despite the greatest possible care, there should ever be cause for complaint, please contact us briefly, as we are very concerned about your satisfaction and would like to clear up any misunderstanding.

During the first operation:

As the heating elements are covered with a light film of oil at the factory for reasons of protection, you will notice a slight smell of burning and possibly also some smoke during the first operation. This is quite normal at first and is caused by the fact that the oil film is now burnt by the heating elements during operation.

Important safety instructions:

- Only use the recommended voltage for operating the unit !
- The heater is not suitable for use outdoors or in other wet or damp environments !
- Please note that the heater can become very hot during operation, so keep a sufficient distance from flammable or easily combustible objects at all times !
- Do not place the heater directly next to a power socket !
- Do not use a timer or automatic on/off switch in conjunction with this heater !
- Never use the heater on moving surfaces, objects or vehicles ! There is a risk that the heater may tip over.
- It is recommended to use a separate power source (socket) only for the supply of the heater. (Please do not use multiple sockets to operate the heater) !
Furthermore, please ensure that the power cable is always laid with sufficient distance to the heat source.
- Supervise the heater when children are near the appliance !
- Be aware of electricity, never walk into or insert objects into the appliance ! Never reach near the plug or socket with wet hands !
Never touch the heater or the power cables with wet hands!
- Do not place any objects on the heater !
- Do not block the supply and/or exhaust air of the unit and please ensure sufficient space/clearance around the unit !
- Ensure that there is sufficient air supply to the unit, otherwise it can lead to a reduction in performance and, in the worst case, to overheating and/or fire !
- Only qualified personnel or electricians are allowed to open the unit !
- Make sure that no moisture gets into or onto the unit !
- Make sure that the power cable is completely unfolded before connecting it to the socket !
- Make sure that the plug is cleanly and properly connected to the socket before using the appliance !
- Make sure that highly flammable substances (e.g. gases/oils etc.) are never in the vicinity of the unit !
- If the connecting cable of this appliance is damaged, it must be replaced by the manufacturer or its after-sales service or a similarly qualified person in order to avoid hazards.
- This appliance is not intended to be used by persons (including children) with reduced physical, sensory or mental capabilities, or lack of experience and/or knowledge, unless they have been given supervision or instruction concerning use of the appliance by a person responsible for their safety.
- If you are not going to use the unit for a long time, switch it off and disconnect the mains plug !

Please switch off the unit immediately and disconnect it from the mains/power supply if anything seems to be wrong !!! In this case, please contact a specialist and do not try to repair the unit yourself !!!

Example: Fan does not run during operation, you notice sparks or the fuse has blown.

Description of the unit parts:

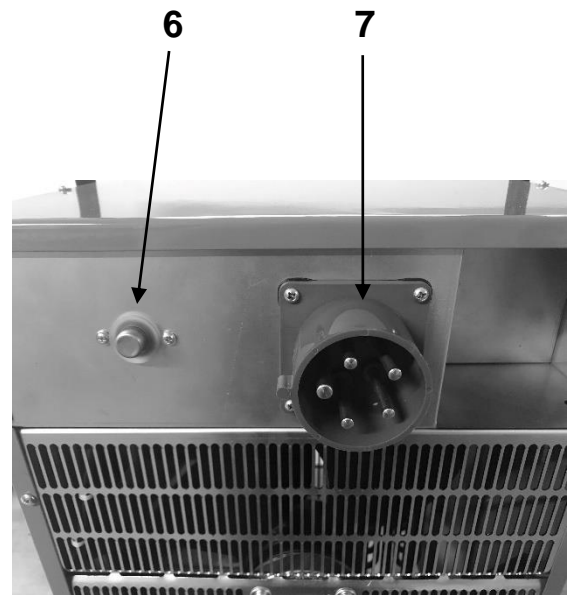
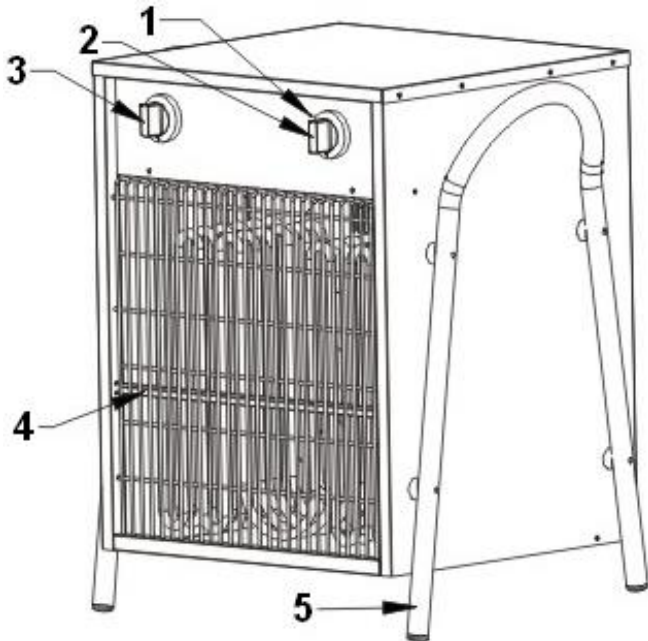

Front:

- 1 Reset button (reset button)
- 2 Thermostatknob
- 3 Operating strength adjustment knob (ON/OFF)
- 4 Superheat sensor
- 5 Standing foot / transport handle

Back:

- 6 Thermostat sensor
- 7 Power connection (400 V)

Description of the control panel:



1. Operating strength adjustment knob

2. Thermostat control dial

Instructions for use:

1. Commissioning

1.1. You need a suitable power cable for connection. This connection cable is not included in the scope of delivery, please use a connection cable with the following specification for this purpose:

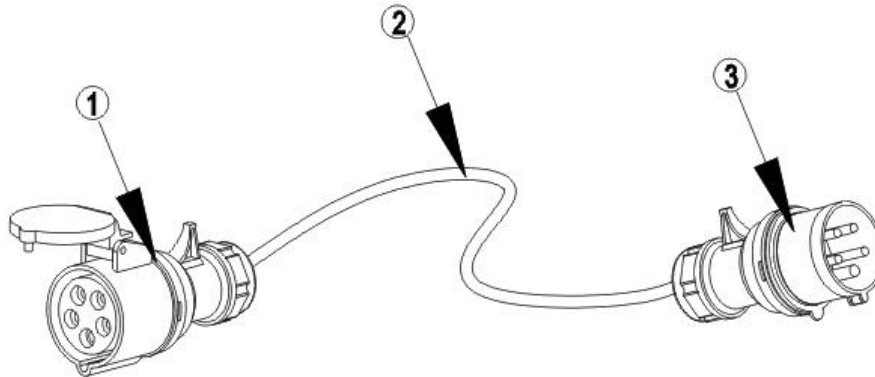

- (1) Five-pole power connection 380V/415V (50/60Hz, 32A)
- (2) Five-core power cable H07RN-F (5G4 mm²)
- (3) Five-pole power plug 380V/415V (50/60Hz, 32A)

1.2. Connect the power cable properly to the heater. To do this, open the protective flap of the five-pole power connection (see illustration below). Now connect the plug head of the power cable to the socket provided for this purpose at the back of your heater. It is important that the power connection is firmly seated in the connecting socket. Finally, connect the power plug properly to a power socket.

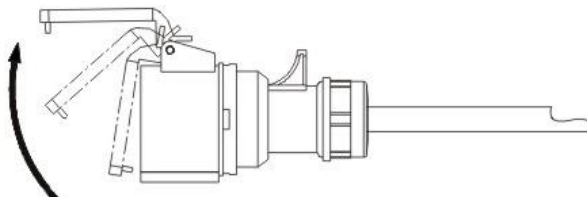

1.3. Select the desired unit power with the operating power adjustment knob (left-hand knob).

- ⓪ = Off
- ⊗ = Fan operation
- Ⓛ = Level 1 (low operating power with 10 kW heating power)
- Ⓜ = Level 2 (high operating power with 20 kW heating power)

1.4. Now set the desired temperature switch-off point (0 ~ 40° C) with the stepless thermostat control dial (right-hand knob). It is best to do this as follows: Turn the thermostat knob to the highest temperature (MAX.) and let the heater run until your desired temperature value is reached. Now turn (adjust) the control downwards towards the minimum until the heating function switches off automatically. Now leave the control dial (thermostat) in this position and whenever it gets colder in the room, the heating rod automatically starts to heat and when the adjusted temperature is reached again, the heating rod automatically switches off again!

Note: The fan of the heater is not controlled by the thermostat. If the selected target temperature is reached, the heating element switches off automatically, but the fan continues to run !

2. Switch off

To switch off the unit, turn the stepless thermostat control knob (right-hand knob) to minimum (MIN) and let the unit run in fan mode for about 5 minutes to allow it to cool down.

Afterwards, also turn the operating strength adjustment knob to "0" to switch off the unit completely.

3. Manually resetting the high-voltage heater

In case of malfunction of the heater, e.g. no heat output, overheating or other problems, the following procedure is recommended:

- 3.1 Unplug the heater from the mains and let it cool down.
- 3.2 Check that the operating strength adjustment knob is in the OFF position and the thermostat control dial is turned to MIN.
- 3.3 Take a pointed pen/object and press the reset button until you hear a short click (see fig.). This resets or zeroes the electrical system of the heater.
- 3.4 Now you can reconnect the heater to the mains plug and the heater should work properly again.

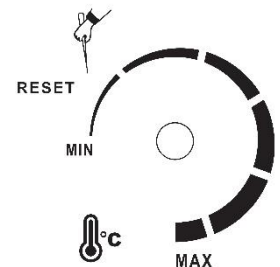

4. Cleaning & Storage

Always unplug the heater from the mains and allow it to cool down completely before cleaning it !

4.1 Cleaning the housing:

- Use a soft and damp cloth to clean the outside of the housing.
- Use only mild cleaning agents to clean your heater and no aggressive cleaning agents, these can damage your appliance !
- Please make sure that no water gets inside your heater at any time !

4.2 Storage:

- We recommend that you repack the unit in its original box for storage.
- Store the heater in a dry and sufficiently ventilated place/space.

5. Other operating instructions

- 5.1. Do not disconnect the mains plug by pulling on the power cable !
- 5.2. Do not use insect repellent, oil spray, paint spray, etc. near the heater. This may cause damage to the unit or even fire or explosion !
- 5.3. Do not place the appliance on sloping or uneven ground !
- 5.4. Please always keep a sufficient distance to the wall to avoid possible overheating of the appliance.
- 5.5. For an effective and economical heating operation, please close all doors and windows in the room of the heater !

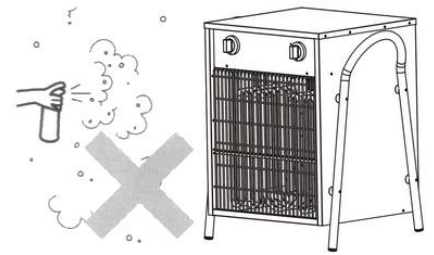

Technical data

Model designation:	WDH-IFH20
Voltage:	400V ~ 50Hz
Max. Power consumption:	20 kW
Connection:	32 A
Heating stages:	2 (1 = 10 kW, 2 = 20 kW)
Thermostat:	Stepless adjustment (0 ~ 40 °C)
Air flow rate:	Approx. 3,084 m ³ /h
Rated heat output:	20.0 kW
Minimum heat output:	10.0 kW
Max. cont. heat output:	20.0 kW
Auxiliary power consumption elmax:	N/A
Auxiliary power consumption elmin:	N/A
Auxiliary power consumption elSB:	N/A
Type of temperature control:	With mechanical thermostat
Protection class:	IPX4
Dimension (H/W/D):	600 x 430 x 380 mm
Weight:	19,5 kg

There may be deviations in the technical data!

Other

Warranty statement:

Notwithstanding the statutory warranty claims, the manufacturer grants a warranty in accordance with the laws of your country, but at least 1 year (in Germany 2 years for private individuals). The warranty begins on the date of sale of the appliance to the end user.

The warranty only covers defects that are due to material or manufacturing faults.
are.

Warranty repairs may only be carried out by an authorised customer service. To
To make your warranty claim, please enclose the original sales receipt (with date of sale).

Excluded from the guarantee are:

- Normal wear
- Improper applications, such as overloading the appliance or non-approved accessories.
- Damage due to external influences, use of force or foreign objects
- Damage caused by non-observance of the operating instructions, e.g. connection to the wrong mains voltage or non-observance of the installation instructions.
- Completely or partially dismantled units

Conformity:

The E-Heater has been tested and itself and/or parts thereof have been manufactured under the following (safety) standards:

Tested by TÜV Rheinland "GS" and of course with CE (LVD + EMC) conformity.

Tested safety according to: EN 62233:2008
EN 60335-2-30:2009+A11
EN 60335-1:2012+A11+A13+A1+A14+A2
AfPS GS 2019:01 PAH

CE (LVD) Conformity tested according to: EN 60335-2-30:2009+A11
EN 60335-1:2012+A11+A13+A1+A14+A2
EN 62233:2008

CE (EMC) conformity tested according to: EN 55014-1:2017
EN 55014-2:2015
EN IEC 61000-3-11:2000
EN 61000-3-12:2011

Correct disposal of this product:



Within the EU, this symbol indicates that this product should not be disposed of with household waste. Waste equipment contains valuable recyclable materials that should be recycled and not harm the environment or human health through uncontrolled waste disposal. Therefore, please dispose of old appliances via suitable collection systems or send the appliance for disposal to the place where you purchased it. They will then recycle the appliance.

I wish you much pleasure with this appliance.

Your Aktobis AG

Keep these instructions for use in a safe place !

